

HARDANGER

TECHNIQUE



1  = 2 tråde i stoffet - 2 trådar i väven - 2 threads in the fabric -
 2 Fäden in dem Stoff - 2 draden in de stof - 2 fils dans le tissu -
 2 fili nel tessuto - 2 cabos en el tejido - 2 lankaa kankaassa - 2 tråder i stoffet

DMC
 Art. 115/5
 Art. 415/5
 Art. 116/8

Sy med helt garn
 Sy med helt garn
 Work with full thread
 Mit ungeteiltem Garn sticken
 Met ongesplitst garen werken
 Broder avec du fil non divisé
 Ricamare con filato intero
 Brodar con el hilo sin dividir
 Ompele täydellä langalla
 Sy med helt garn



Art. 115/5 - Art. 415/5

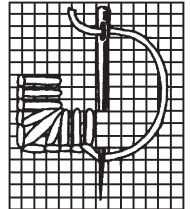

Art. 115/5 - Art. 415/5

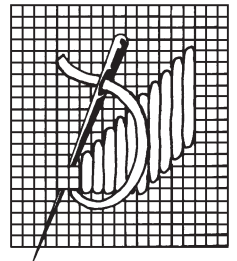

Art. 116/8

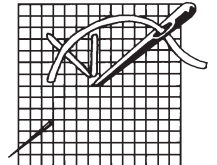

Art. 116/8

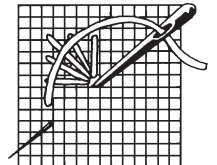

Art. 116/8

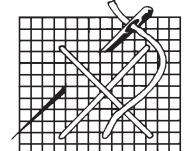

Art. 116/8

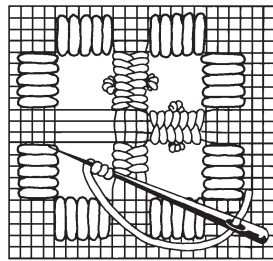

Art. 116/8

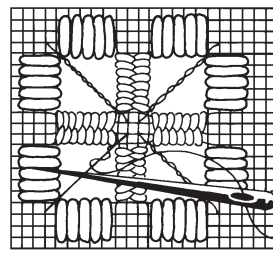

Art. 116/8

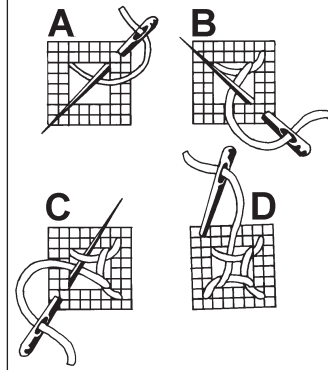

Art. 116/8

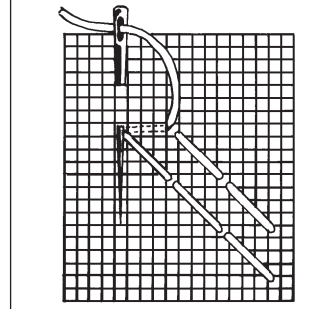

Art. 116/8

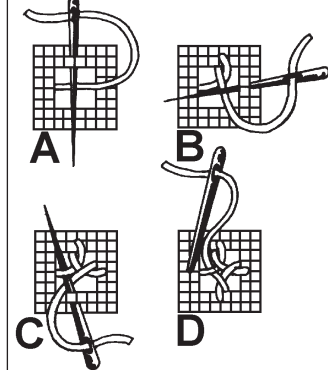

Art. 116/8

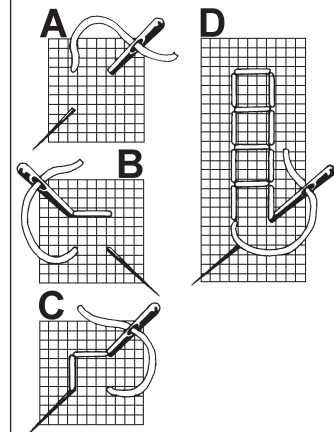

Art. 115/5 - Art. 415/5

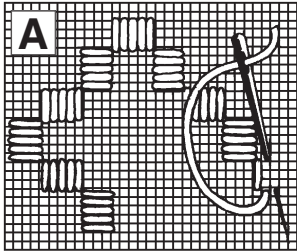

Art. 115/5 - Art. 415/5

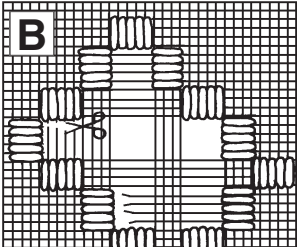

Art. 116/8

